

Side View - Retracted

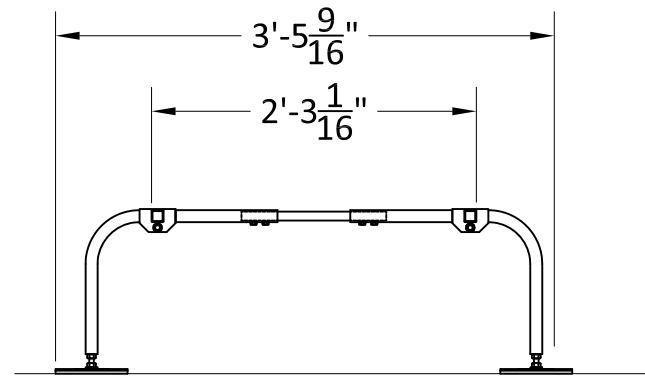

Side View - Expanded

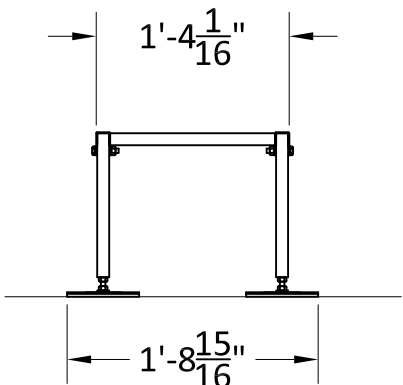

End View - Fixed

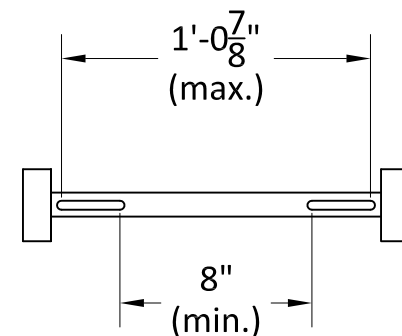

Spacer Bar Detail
(Showing Range of Bolt Spacing)



ASSEMBLY DRAWING
"MINI-SPLIT 12"
ADJUSTABLE STAND - THIN
MODEL NO. QSMS1200

www.quick-sling.com
email: info@quick-sling.com
fax: 1-(800)-699-0423

Quick Sling, LLC
391 W. Water Street
Taunton, MA 02780
1-(800)-699-0543