

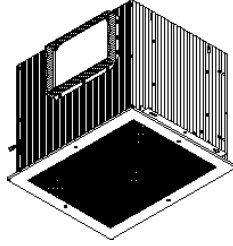

P: 800.961.7370
www.solerpalau-usa.com

SPECIFICATION SHEET

FF900 & FF1500 CEILING MOUNT VENTILATORS



Incredibly reliable. Unbelievably quiet. Offering the CFM choices you need at the lowest sound levels in the industry.

FEATURES

GRILL:

- Conceals interior
- Low profile styling blends with any decor
- Metal, finished with white painted enamel

BLOWER:

- Low RPM for quiet operation
- Resilient anti-vibration mounts
- Dynamically-balanced, polymeric, centrifugal blower wheel for quiet, efficient performance
- Permanently lubricated, thermally protected motor
- Plug-in motor rated at 120 VAC
- Designed for continuous operation

HOUSING:

- Rugged, 20 gauge galvanized steel
- 1/2" acoustic insulation inside
- May be installed in ceiling or wall (size permitting)
- 8-position mounting brackets for easy installation and greater adaptability to various mounting requirements
- Automatic backdraft damper located within duct connector
- Factory-shipped in horizontal discharge position for 8" x 12" ductwork
- May be converted to vertical discharge
- May be installed as an in-line ventilator with addition of accessory kit Model 983L

ACCESSORIES (purchase all separately):

- Model T81212 Transition (8" x 12" to 12" round)
- Model RD3 Radiation Damper

TYPICAL SPECIFICATION

Ventilator shall have galvanized steel housing insulated with at least 1/2" of acoustic insulation. Housing to have adjustable mounting brackets.

Automatic backdraft damper to be located within duct connector. Duct connector, blower assembly and wiring plate shall be adjustable for either horizontal or vertical installation.

Blower unit shall be removable from housing and will have a polymeric, centrifugal-type blower wheel. Motor to be permanently lubricated and mounted with resilient anti-vibration mounts. RPM not to exceed number listed for each model.

Air delivery shall be no less and sound levels no greater than listed for each model. All air and sound ratings shall be certified by AMCA. Units to be cULus listed.

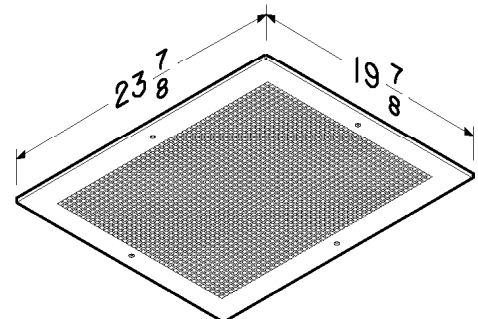
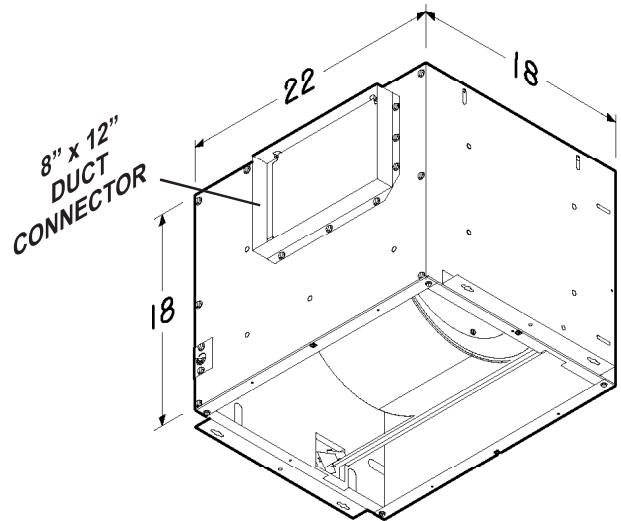

Breidert Air Products, div. of Soler & Palau Ventilation Group, certifies that the models shown herein are licensed to bear the AMCA Seal. The ratings shown are based on tests and procedures performed in accordance with AMCA Publication 211 (and AMCA Publication 311 if sound is also certified) and comply with the requirements of the AMCA Certified Ratings Program.



cULus listed for use over bathtubs and showers when connected to a GFCI-protected branch circuit.

WEIGHT

MODEL NO.	SHIPPING WT.
FF900	64.2 lbs
FF1500	64.3 lbs

PERFORMANCE RATINGS - CEILING MOUNT VENTILATORS FF900 & FF1500

AMCA LICENSED PERFORMANCE RATINGS

MODEL NO.	NOMINAL VOLTAGE	CFM/SONES - AT STATIC PRESSURES (Ps - inches of H ₂ O)										NOMINAL RPM	AMPS @ 60 Hz	WATTS				
		0.0"	.10"	.125"	.250"	.375"	.50"	.625"	.750"	.875"	1.0"							
		Ps	Ps	Ps	Ps	Ps	Ps	Ps	Ps	Ps	Ps							
FF900	120 VAC	CFM Hor.	918	905	901	877	842	793	725	636	536	390	650	3.0	306			
		SONES Hor.	3.8	4.0	4.1	4.0	4.2	4.3	4.4	4.9	4.5	5.3						
		CFM Ver.	909	892	885	850	807	756	695	568	440	282				650	3.0	306
		SONES Ver.	3.8	3.4	3.4	3.5	3.6	3.7	3.9	4.2	4.3	4.4						
FF1500	120 VAC	CFM Hor.	1578	1526	1513	1438	1371	1285	1198	1103	1000	816	955	5.0	468			
		SONES Hor.	8.6	8.4	8.4	8.1	7.5	7.0	6.7	6.2	5.8	5.8						
		CFM Ver.	1590	1519	1502	1423	1340	1259	1176	1069	954	689				955	5.0	468
		SONES Ver.	8.5	8.4	8.4	8.1	7.9	7.5	7.2	7.1	6.9	6.5						

Performance ratings include the effects of inlet grill and backdraft damper in the airstream. Speed (RPM) shown is nominal. Performance is based on actual speed of test. The sound ratings shown are loudness values in fan sones at 5' (1.5m) in a hemispherical free field calculated per AMCA Std. 301. Values shown are for Installation Type B: Free inlet fan sone levels. Performance shown is for Installation Type B: Free inlet, Ducted outlet.



Breidert Air Products, div. of Soler & Palau Ventilation Group, certifies that the models shown herein are licensed to bear the AMCA Seal. The ratings shown are based on tests and procedures performed in accordance with AMCA Publication 211 (and AMCA Publication 311 if sound is also certified) and comply with the requirements of the AMCA Certified Ratings Program.



cULus listed for use over bathtubs and showers when connected to a GFCI-protected branch circuit.

